

LIGHT SKY®

FLY DRAGON LIGHTING EQUIPMENT CO.,LTD

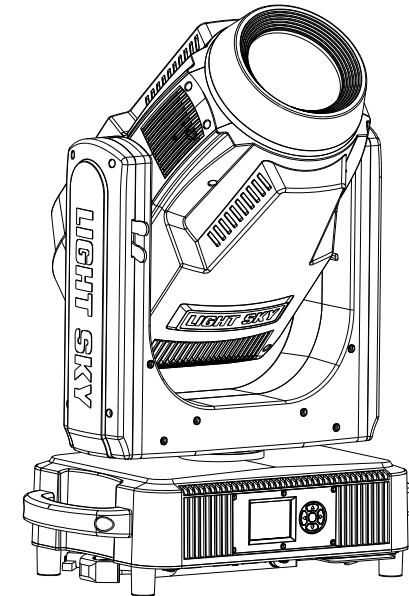

LIGHT SKY®

Tel:0086-20-61828288

Fax:0086-20-61828188 Pc:510800

Web:www.lightsky.com.cn

E-mail: flydragon@lightsky.com.cn

asia@lightsky.com.cn

india@lightsky.com.cn

europa@lightsky.com.cn

latinamerica@lightsky.com.cn

middle-east@lightsky.com.cn

american@lightsky.com.cn

Address: No. 43, Yunfeng Road, Xiuquan Street,
Huadu District, Guangzhou, China



LIGHT SKY®



SUPER SCOPE- USER MANUAL

Please read these user manual carefully before use!

Contents

1. Safety information.....	2
2. Technical information.....	4
3. Attachment and body size.....	8
4. Installation and connecting.....	9
5. Control panel.....	12
6. Menu setting.....	13
7. Channel function.....	18
8. Circuit connecting diagram.....	24
9. Cleaning and maintenances.....	25
10.Troubeshooting.....	26
11.Duty exonerative and copyright protection.....	28

Congratulations on choosing our company product! We thank you for your custom.

- ◆Please note that this product, as all the others in the rich my company range, has been designed and made with total quality to ensure excellent performance and best meet your expectations and requirements.
- ◆Carefully read this user manual in its entirety and keep it safe for future reference. It is essential to know the information and comply with the instructions given in this manual to ensure the fitting is installed, used and serviced correctly and safely.
- ◆My company disclaims all liability for damage to the fitting or to other property or persons deriving from installation, use and maintenance that have not been carried out in conformity with this user manual, which must always accompany the fitting.
- ◆My company reserves the right to modify the characteristics stated in this user manual at any time and without prior notice.

SAFETY INFORMATION



■ This lighting fixture is for professional use only - it is not for household use.

■ Installation

Make sure all parts for fixing the projector are in a good state of repair.

Make sure the point of anchorage is stable before positioning the projector.

The safety chain must be properly hooked onto the fitting and secured to the framework.

When suspending the fixture, ensure that the supporting structure and all hardware used can hold at least 10 times the weight of all the devices they support.

o



■ Mounting surface and fire protection

Please do not install the fixture onto combustible surface.

Keep all combustible materials at least 20 cm away from the fixture.

Ensure a minimum clearance of 0.2m around the cooling fans and ventilation.



Do not expose the front glass to sunlight or other strong light source from any angle.

Lenses can focus the sun's rays inside the fixture, creating a potential fire hazard.

ta40°C



■ Maximum ambient temperature

The fixture is intended for indoor application.

Do not operate the fixture if the ambient temperature (Ta) exceeds 40°C.



■ Protection against electrical shock

Connection must be made to a power supply system fitted with efficient earthing (Class I appliance according to standard EN 60598-1).

It is, moreover, recommended to protect the supply lines of the projectors from indirect contact and/or shorting to earth by using appropriately sized residual current devices.



■ Connection to mains supply

The double insulation between the LV power supply and the control conductor on the fixture. Connection to the electricity mains must be carried out by a qualified electrical installer.

Check that the mains frequency and voltage correspond to those for which the projector is designed as given on the electrical data label.

This label also gives the input power to which you need to refer to evaluate the maximum number of fittings to connect to the electricity line, in order to avoid overloading.

Don't use the power cable when the insulation is damaged.

It must be the manufacturer or distributor or the professional person to change the damaged power cable in order to avoid any dangerous.



t_c 80 °C



■ **Temperature of the external surface**

The maximum temperature that can be reached on the external surface of the fitting, in a thermally steady state, is 80 °C.

Avoid contact by persons and materials.

Allow the fixture to cool for at least 15 minutes before handling.



■ **Maintenance**

Before starting any maintenance work or cleaning the projector, cut off power from the mains supply.

After switching off, do not remove any p



■ **Light**

The light source in this fixture shall be replaced by the manufacturer or its service agent or similar qualification.

Always disconnect from mains before replacing the light.



■ **Protection against explosion**

The protection screen, lens or uv screen on the lamp can be damaged to the degree of failure if visible damage, such as a crack or deep mark, should be replaced.



■ **Protection optical radiation**

Never look directly into the light source. You risk injury to your retina, which may induce blindness.



Do not look at LEDs with magnifiers, telescopes, binoculars or similar optical instruments that may concentrate the light output.



■ **Battery**

This product contains a rechargeable lead-acid battery. To preserve the environment, please dispose the battery at the end of its life according to the regulation in force.



The products referred to in this manual conform to the European Community Directives to which they are subject:

Low Voltage 2014/35/EU

Electromagnetic Compatibility 2014/30/EU

TECHNICAL INFORMATION

- **Power supplies available :**
 - AC100-240V~, 50/60Hz
 - 190-240V/4.5A; 100-125V/8.5A
- **Rated power :**
 - 850W PF 0.980
- **Light source**
 - 580W white light LED module
 - Light source power : 580W
 - Colour temperature:6300K
 - Average life :20000h
- **Motors :**
 - 20 ultra-quiet motors
- **Channe :**
 - Standard channel:27CH; Extension channel:33CH
- **Protocols:** DMX-512, RDM, Art-Net
- **Color wheel**
 - 8 colors + white, Bi-direction rainbow effect
- **Color mixing system**
 - Linear CMY+CTO color mixing system
- **Enhance CRI color rendering :**
 - Can increase to 91 the above
- **Static gobo wheel**
 - ϕ 138 9Gobo + 1 white + animation
- **Rotation Gobo Wheel**
 - 7 rotating Gobos + white, Bi-direction flow water animation effect, Design size: inside diameter 17, outside diameter 22.9 .
- **Strobe**
 - 1-25 times/second
- **Dimmer**
 - Electronic dimmer, 0-100% linear adjustment.
- **Prism**
 - 4 Prism+16 double Prism+multi combination effect
- **Beam angle:**
 - 6°-50°
- **Frost**
 - 1° and 10° two levels of atomization

- **Focus and Lens**
 - ϕ 127High precision optical lens, linear adjustment
- **X/Y Travel:**
 - Pan movement 540°, Tilt movement 270°
- **X/Y Resolution:** 2.11"/1.05°
- **X/Y Speed:** 2.7S/2.1S
- **Software upgrade**
 - Insert USB upgrade software.
- **Display**
 - Display panel adopts 2.8 inch resistive color touch screen with good pressure sensitivity
 - Chinese and English languages can be switched freely, menu available to display 180°reversely
- **IP set**
 - Automatic chang battery, IP could be set without electricity.
- **Features**
 - Input signal isolation: guarantees stable signal transmission without interference.
 - Advanced Art-Net function
- **IP20 protection**
- **Safety Devices**
 - BIPOlar circuit breaker with thermal protection.
- **Cooling**
 - Forced ventilation with axial fans.
- **Structure**
 - Heat-proof plastic+module pressing alloy materials.
- **CE Marking**
 - In conformity with the European Union Low Voltage Directive 2014/35/EU and Electomagnetic compatibility Directive 2014/30/EU.
- The vertical direction of the use of hidden locking device, convenient transportation and maintenance.
- **Lighting Size :** 510X300X731MM
- **Box Size :** 810X580X395MM
 - N.W.: 31.5kg , G.W.: 35.5kg
- **Flycase Size (1SETS):**
 - 620X580X850MM
 - N.W.: 31.5kg , G.W.: 64.5kg

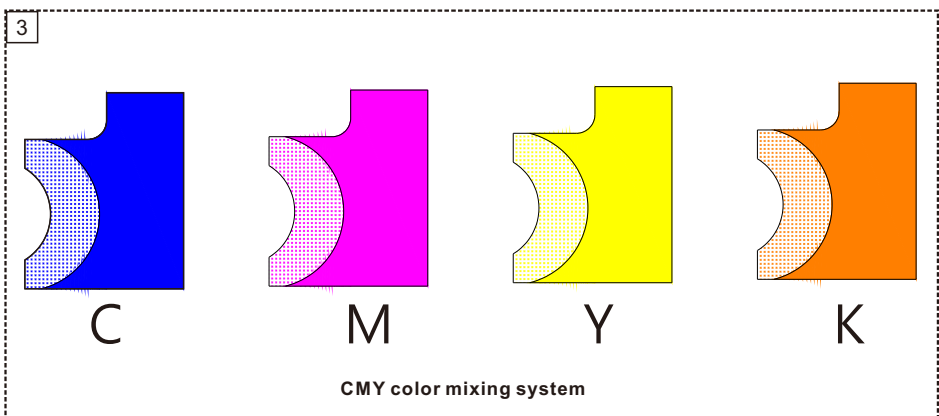
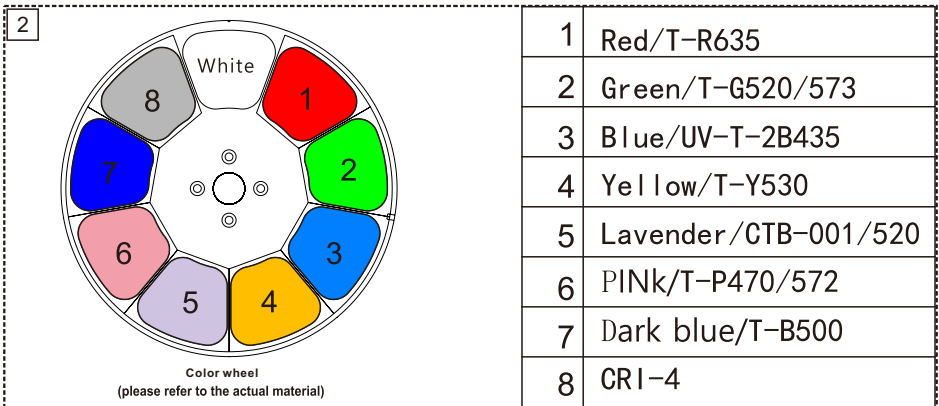
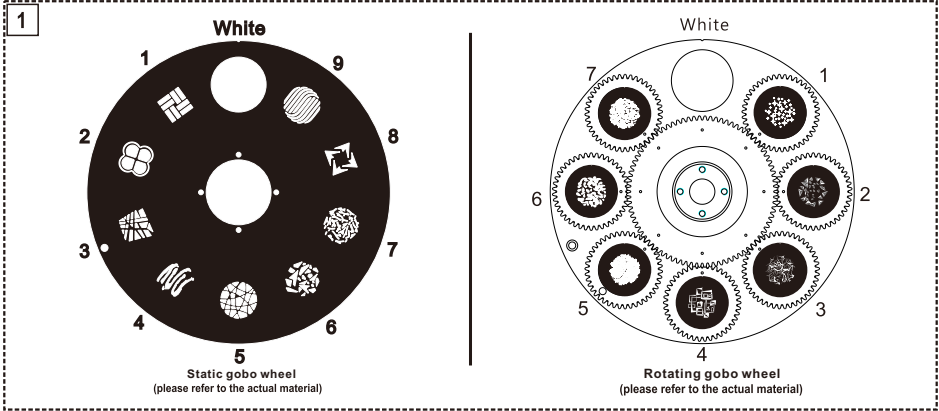

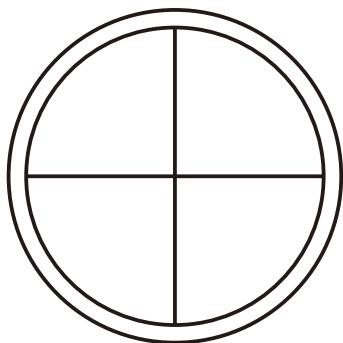

4 Prism

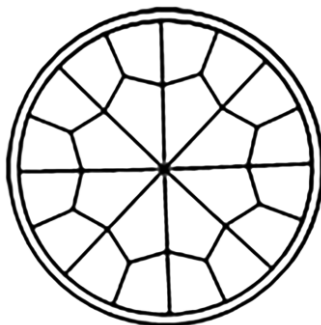

16 double Prism

distance, spot diameter and illumination diagram Standard (6° - 50°)

Lux(fc)

50° highlights	1970(183)	512(48)	206(19)	132(12)	58(5)	37(3)	23(2)
6° highlights	60500(5623)	15000(1394)	6520(606)	3750(349)	2650(153)	1918(178)	580(54)

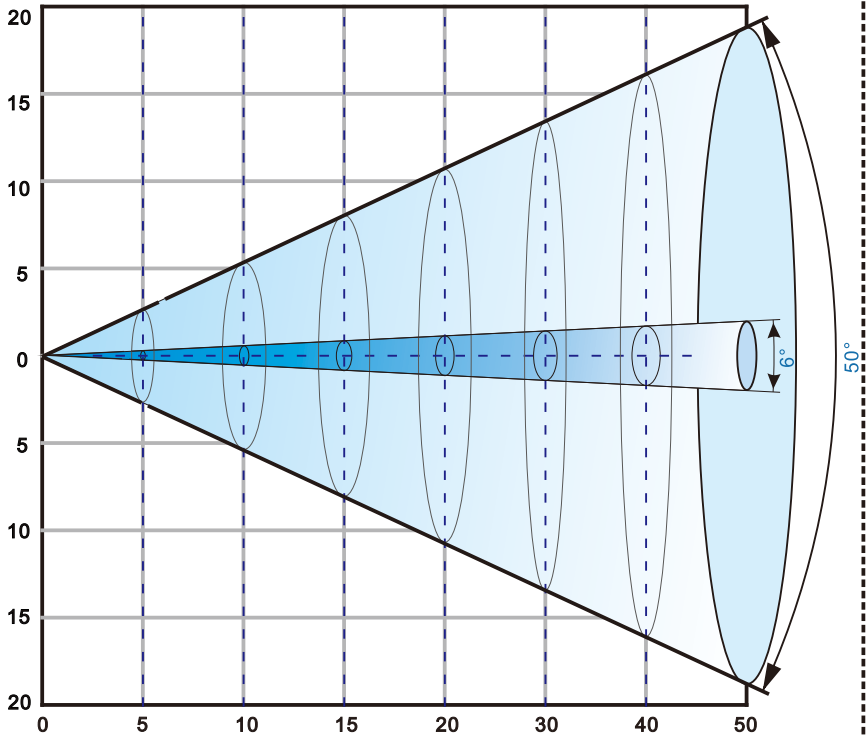

Distance m							
6° diameter m(ft.in)	0.55(1'10")	1.05(3'5")	1.58(5'2")	2.10(6'11")	3.23(10'7")	4.3(14'1")	5.0(16'4")
50° diameter m(ft.in)	4.72(15'6")	9.57(31'5")	14.4(47'3")	18.95(62'2")	28.25(92'8")	37.6(123'4")	46.8(153'6")

ATTACHMENT AND BODY SIZE

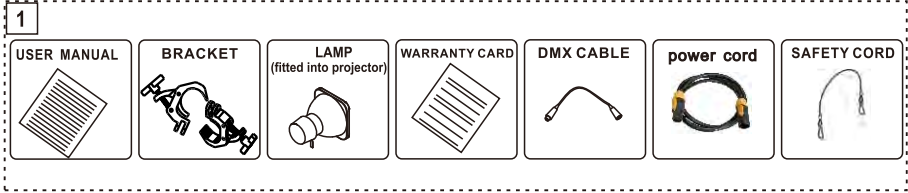

Attachment contents- Fig. 1

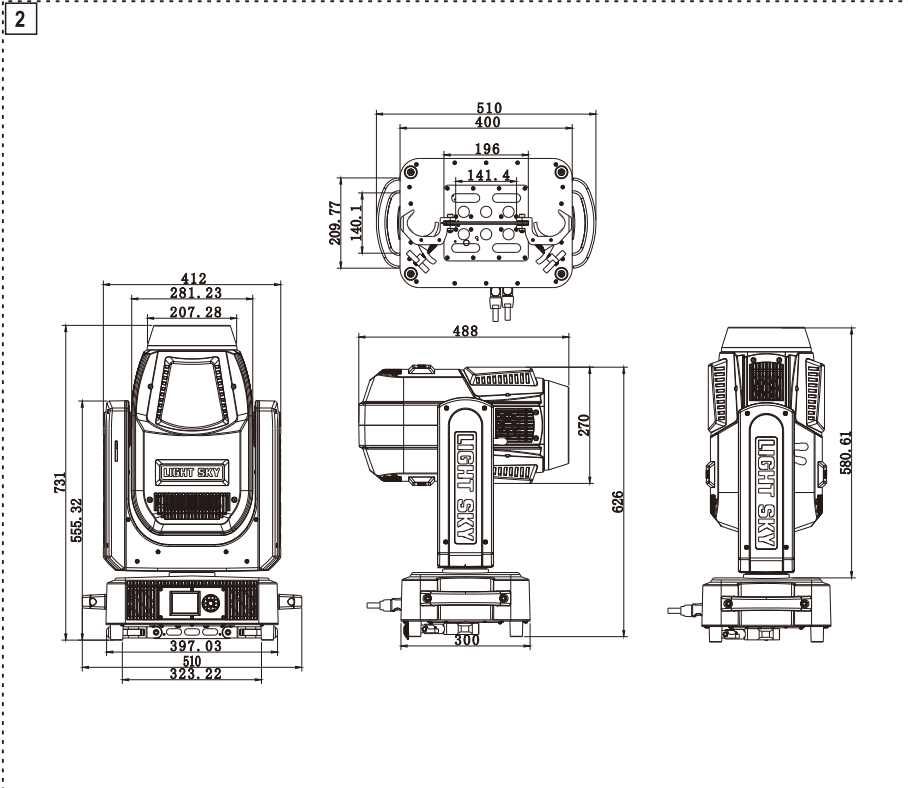

Body Size---Fig 2

INSTALLATION AND CONNECTING

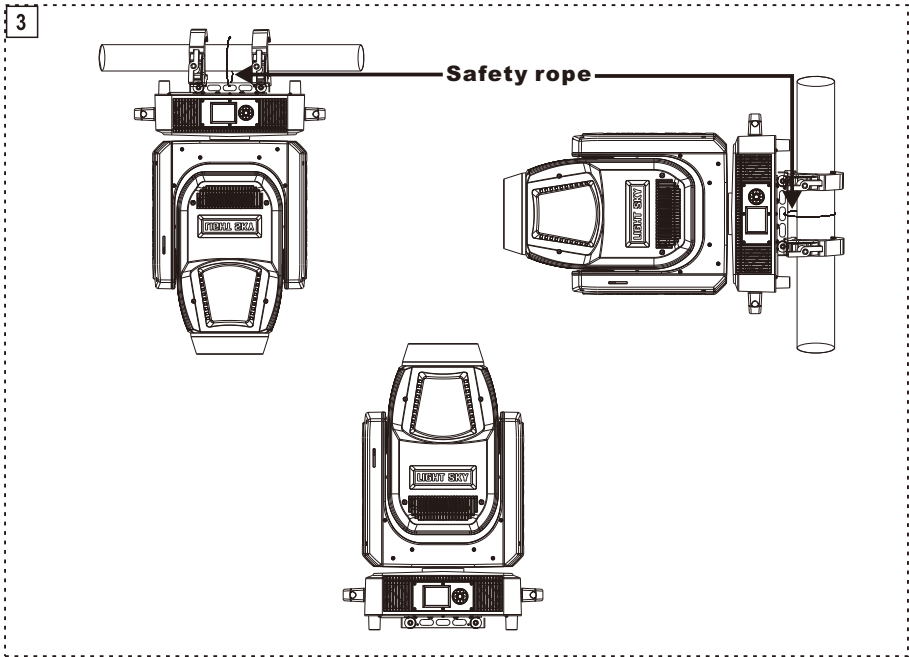

Compact, standard clamp system equipped & easy installation

The fixture can be installed on the floor resting on special rubber feet, on a truss or on the ceiling or wall.

WARNING: with the exception of when the fixture is positioned on the floor, the safety rope must be fitted.

This must be securely fixed to the support structure of the fixture and then connected to the fixing point at the centre of the base.

Make sure all parts for fixing the fixture are in a good state of repair.

Make sure the point of anchorage is stable before positioning the fixture.

When suspending the fixture, ensure that the supporting structure and all hardware used can hold at least 10 times the weight of all the devices they support.

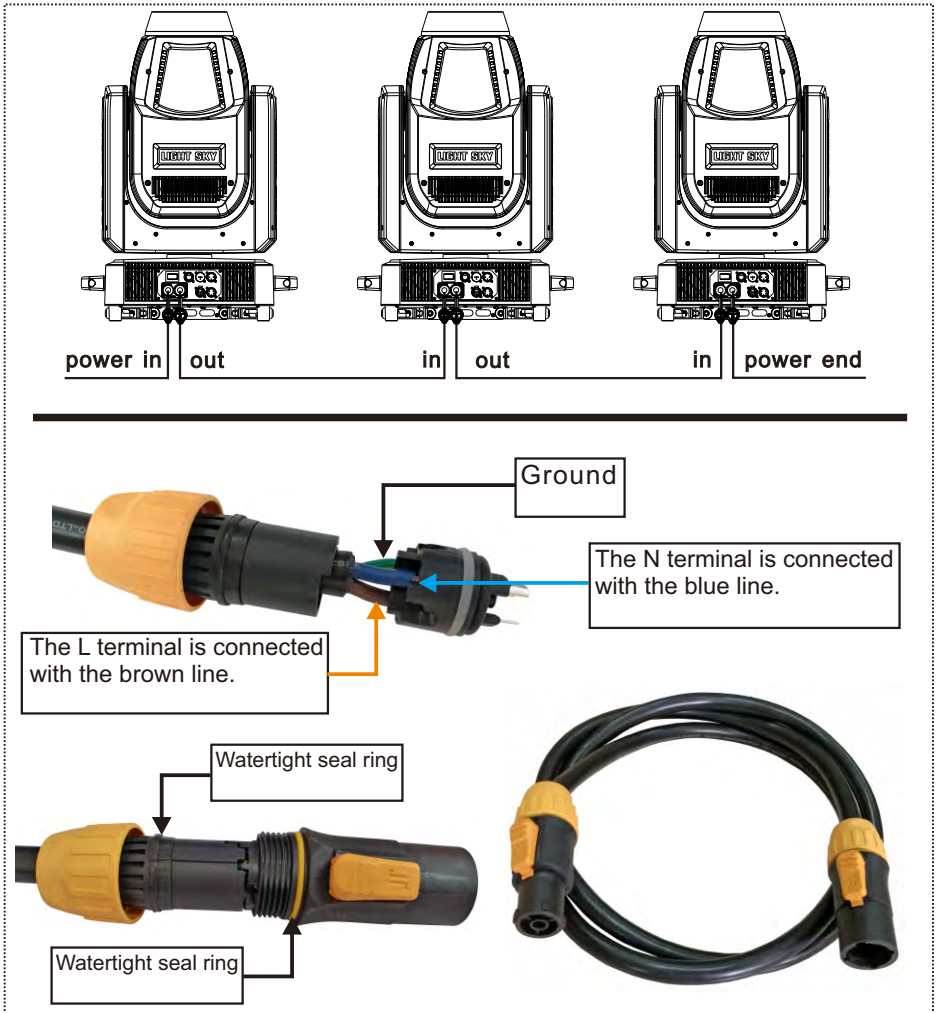

- The fixture delivers a three-core waterproof plug.
- The fixture power supply can not be more than 2pcs pre line.
- Connection to the electricity mains must be carried out by a qualified electrical installer.
- After doing the above operation and making sure all the devices had been installed with natural operate, press the power switch to check whether everything is working normally.

5

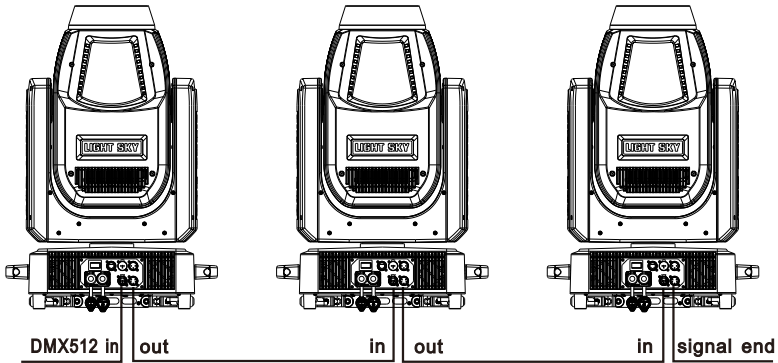

DMX - output

- 1- Shield
- 2- Signal (-)
- 3- Signal (+)
- 4- Not connected
- 5- Not connected

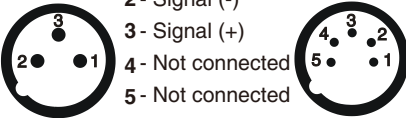

DMX-input

- 1- Shield
- 2- Signal (-)
- 3- Signal (+)
- 4- Not connected
- 5- Not connected

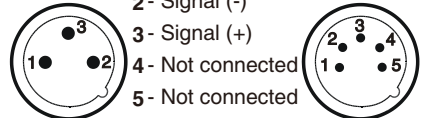





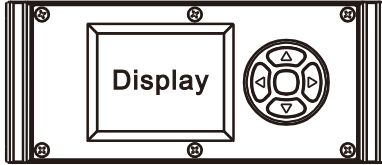

Connecting to the control signal line (DMX) - Fig. 5

- © Please use the round 3 or 5-pin XLR plugs & sockets offered by menu factory to connect the first projector's output to the second projector's input and connect the second projector's output to the third projector's input. And in the same way for the rest, eventually connect the last projector's output, all the projectors are together.
- © The projectors' control signal output or input by using the 3 or 5-pin XLR plug and socket. If need to lengthen the communication cable, please make sure the both side of 3 or 5-pin plug is one to one. (one to one, two to two, three to three). Otherwise, the communication cable will be interrupted. The communication cable is 2-core screened cable 75Ω resistance with each core is at least a 0.5mm diameter. (**Caution:** All the inside leading wire of 3 or 5-pin XLR plug couldn't touch each other or plinth).
- © Recommend to use the DMX signal terminator for the installation to avoid the electronic noise damage the digital control signal. Simply speaking, DMX terminator is an XLR connector with a 120Ω 1/2W resistor connected across pin 2 and 3. Which is then plugged into the output socket on the last projector in the chain. Refer to the connection.

CONTROL PANEL

6



-  Up arrowhead:page up
-  Down arrowhead:page down
-  Left arrowhead:page left or reduce
-  Right arrowhead:page right or increase
-  Enter:OK function
-  Exit:in the choice screen

Press the switch. The projector starts resetting the effects. At the same time, the following information scrolls on the display (please refer to the actual material):

Display

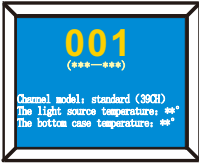

ENTER



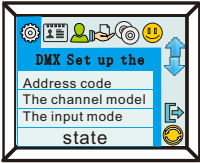





DMX SETTING



Info



Person



Manual



Test



Service



Page up



Page down



Exit



Switch between Chinese and English

Display panel adopts 2.8 inch resistive color touch screen with good pressure sensitivity

Chinese and English languages can be switched freely.

MENU SETTING(V1.0)

Main menu	I menu	II menu	III menu	IV menu
DMX SETTING	Address	→ 1-512		
	Channel mode	→ Extended (33)		
		→ Standard (27)		
	Input mode	→ DMX 512 → Art-Net		
State	→ Blackout → Hold			
Info	Fixture times	→ Power on time		
		→ LED on time		
		All time		
	Temperatures	→ LED TEMP		
		→ Base TEMP		
	RDM info	→ UID:0x3888XXXXXX		
		→ Manufacturer Label: LIGHT SKY		
		→ Device Label: SUPER SCOPE-		
	DMX live	→ 1. Pan		
		2. Pan fine		
		3. Tilt		
		4. Tilt Fine		
		5. P/T speed		
		6. Functions		
		7. Cyan		
		8. Cyan fine		
		9. Magenta		
		10. Magenta fine 调		
		11. Yellow		
		12. Yellow fine		
		13. CT0		
		14. CT0 fine		
		15. Colour wheel		
		16. Static Gobo		
		17. Rot. Gobo		
		18. Gobo Rot		
		19. Prism1		
		20. Prism1 Rot.		
21. Prism2				
22. Prism2 Rot				
23. Frost1				
24. Frost2				
25. Zoom				
26. Zoom fine				
27. Focus				
28. Focus fine				
			→ 0 - 255	

Main menu	I menu	II menu	III menu	IV menu			
		29. Auto Dis					
		30. Auto Fin					
		31. Strobe					
		32. Dimmer					
		33. Dimmer fine					
Version info	→	Display	→	VX.XX			
		Pan/Tilt					
		Gobo module					
		Zoom module					
		LEDDRV					
		FANDRV					
Person	Pan/Tilt	→		OFF			
				ON			
				Fan mode	→		
							Standard mode
	Hot mode						
	Display	→	Language	English			
				Chinese			
				Always			
			Backlight time	Auto (30S)			
			Intensity	0 - 100			
			Rotation	Normal			
	Art-Net	→	IP Address	xxx. xxx. xxx. xxx			
			Mask Address	xxx. xxx. xxx. xxx			
			Net Address	0 - 127			
			Sub Net Address	0 - 15			
			Universe Address	0 - 15			
	Led Hz	→	1200Hz / 1200Hz				
			20000Hz / 20000Hz				
			1. Pan				
			2. Pan fine				
			3. Tilt				
			4. Tilt Fine				
			5. P/T speed				
			6. Functions				
7. Cyan							
8. Cyan fine							
9. Magenta							
10. Magenta fine							
11. Yellow							

Main menu	I menu	II menu	III menu	IV menu
Manual	Manual Control	12. Yellow fine	→	
		13. CTO		
		14. CTO fine		
		15. Colour wheel		
		16. Static Gobo		
		17. Rot. Gobo		
		18. Gobo Rot		
		19. Prism1		
		20. Prism1 Rot.		
		21. Prism2		
		22. Prism2 Rot.		
		23. Frost1		
		24. Frost2		
		25. Zoom		
		26. Zoom fine		
		27. Focus		
		28. Focus fine		
		29. Auto Dis		
		30. Auto Fin		
		31. Strobe		
	32. Dimmer			
	33. Dimmer fine			
	Reset	Pan/Tilt reset		
		Color reset		
		Gobo reset		
		Zoom reset		
		Total reset		
	Test	Test all	In the test	
		Test pan/tilt		
		Test effects		
			Memory IC	
			Angle Sensor	
			Pan Encoder	
			Pan Drive IC	

Main menu	I menu	II menu		III menu	IV menu	
Service	Fixture state	Tilt Encoder	→	OK Reset Error		
		Tilt Drive IC				
		LED Fan				
		Bottom Fan				
		Temperature				
		Pan				
		Tilt				
		Cyan				
		Magenta				
		Yellow				
		CTO				
		Frost 1				
		Frost 2				
		Colour wheel				
		Fixation wheel				
		Rota. gobo				
		Gobo. rota				
		Zoom				
	Focus					
	Prism 1					
	Prism 2					
	Fan speed	LED fan 1				
		LED fan 2				
		LED fan 3				
		LED fan 4				
		GOBO fan				
	Adjust	→	Pan	→	0 - 255	
			Tilt			
			Cyan			
			Magenta			
			Yellow			
			CTO			
			Colour wheel			
Fixation wheel						
Rota. gobo						
Gobo. rota						
Zoom						
Focus						
Prism 1						
Prism 2						
Frost 1						
Frost 2						

Main menu	I menu	II menu	III menu	IV menu
		Factory Reset	Password → YES / NO	
		Reset timers	Password → Reset power on timers Reset led timers Reset all timers	YES / NO
	Factory	Update	Password → Simple update Whole update	Display Pan/Tilt Gobo module Zoom module LEDQD FANDRV Display Pan/Tilt / XY Gobo module Zoom module LEDQD FANDRV
		LED output power	Password → 50 - 100	

CHANNEL FUNCTION(V1.0)/27CH

Channel	DMX	Percentage	Functions	Note
1	Pan	0 - 255		
2	Pan fine	0 - 255		
3	Tilt	0 - 255		
4	Tilt Fine	0 - 255		
5	P/T speed	0 - 255		
6	Functions	0 - 10	NO function	
		11 - 20	The whole lamp reset	
		21 - 30	XY reset	
		31 - 40	Color reset	
		41 - 50	pattern reset	
		51 - 60	Cutting reset	
		61 - 70	Focus module reset	
		71 - 80	Silent mode	
		81 - 90	Normal mode	
		91 - 100	High Pattern	
		101 - 110	NO function	
		111 - 120	NO function	
		121 - 130	NO function	
		131 - 140	NO function	
		141 - 150	NO function	
		151 - 160	NO function	
		161 - 170	NO function	
		171 - 180	Show backlight is always on	
181 - 190	Display backlight automatically			
191 - 200	Open the function			
201 - 255	NO function			
7	Cyan	0 - 255		
8	Magenta	0 - 255		
9	Yellow	0 - 255		
10	CTO	0 - 255		
11	Colour wheel	0 - 89	0 - 360°	
		90 - 99	OPEN	
		100 - 109	COLOR1	
		110 - 119	COLOR2	
		120 - 129	COLOR3	
		130 - 139	COLOR4	
		140 - 149	COLOR5	
		150 - 159	COLOR6	
		160 - 169	COLOR7	
		170 - 179	COLOR8	
		180 - 214	CW, Slow→Fast	
		215 - 249	CCW, Fast→Slow	
		250 - 255	Random color	
12	Static Gobo	0 - 9	OPEN	
		10 - 19	GOB01	
		20 - 29	GOB02	
		30 - 39	GOB03	
		40 - 49	GOB04	
		50 - 59	GOB05	
		60 - 69	GOB06	
		70 - 79	GOB07	
		80 - 89	GOB08	
		90 - 99	GOB09	
		100 - 109	GOB01 Jitter slow to fast	
		110 - 119	GOB02 Jitter slow to fast	
		120 - 129	GOB03 Jitter slow to fast	
		130 - 139	GOB04 Jitter slow to fast	
		140 - 149	GOB05 Jitter slow to fast	

Channel	DMX	Percentage	Functions	Note
		150 - 159	GOB06 Jitter slow to fast	
		160 - 169	GOB07 Jitter slow to fast	
		170 - 179	GOB08 Jitter slow to fast	
		180 - 189	GOB09 Jitter slow to fast	
		190 - 199	OPEN	
		200 - 224	CW, Slow→Fast	
		225 - 249	CCW, Fast→Slow	
		250 - 255	Random Gobo	
13	Rot. Gobo	0 - 9	OPEN	
		10 - 19	GOB01	
		20 - 29	GOB02	
		30 - 39	GOB03	
		40 - 49	GOB04	
		50 - 59	GOB05	
		60 - 69	GOB06	
		70 - 79	GOB07	
		80 - 89	GOB01	
		90 - 99	GOB02 Jitter slow to fast	
		100 - 109	GOB03 Jitter slow to fast	
		110 - 119	GOB04 Jitter slow to fast	
		120 - 129	GOB05 Jitter slow to fast	
		130 - 139	GOB06 Jitter slow to fast	
		140 - 149	GOB07 Jitter slow to fast	
		150 - 159	OPEN	
		160 - 204	CW, Slow→Fast	
		205 - 249	CCW, Fast→Slow	
		250 - 255	Random Gobo	
		14	Gobo Rot.	0 - 127
128 - 187	CW, Fast→Slow			
188 - 195	STOP			
196 - 255	CCW, Slow→Fast			
15	Prism1	0 - 10	Prism off	
		11 - 255	Prism Cut-in	
16	Prism1 Rot	0 - 127	0° - 360°	
		128 - 187	CW, Fast→Slow	
		188 - 195	STOP	
		196 - 255	CCW, Slow→Fast	
17	Prism2	0 - 10	Prism off	
		11 - 255	Prism Cut-in	
18	Prism2 Rot.	0 - 127	0° - 360°	
		128 - 187	CW Fast→Slow	
		188 - 195	STOP	
		196 - 255	CCW Slow→Fast	
19	Frost1	0 - 127	Minimum to maximum atomization	
		128 - 159	Slow IN Fast OUT, Slow → Fast	
		160 - 191	Fast IN Slow OUT, Slow → Fast	
		192 - 255	Slow IN Slow OUT, Slow → Fast	
20	Frost2	0 - 127	Minimum to maximum atomization	
		128 - 159	Slow IN Fast OUT, Slow → Fast	
		160 - 191	Fast IN Slow OUT, Slow → Fast	
		192 - 255	Slow IN Slow OUT, Slow → Fast	

Channel	DMX	Percentage	Functions	Note
21	Zoom	0 - 255		
22	Focus	0 - 255		
23	Auto Dis.	0 - 9	NO function	
		10 - 19	5M	
		20 - 29	10M	
		30 - 39	15M	
		40 - 49	20M	
		50 - 59	30M	
		60 - 255	40M	
24	Auto Fin.	0 - 255		
25	Strobe	0 - 255		
26	Dimmer	0 - 255		
27	Dimmer fine	0 - 255		

CHANNEL FUNCTION(V1.0)

Channel	DMX	Percentage	Functions	Note
1	Pan	0 - 255		
2	Pan fine	0 - 255		
3	Tilt	0 - 255		
4	Tilt Fine	0 - 255		
5	P/T speed	0 - 255		
6	Functions	0 - 10	NO function	
		11 - 20	The whole lamp reset	
		21 - 30	XY reset	
		31 - 40	Color reset	
		41 - 50	pattern reset	
		51 - 60	Cutting reset	
		61 - 70	Focus module reset	
		71 - 80	Silent mode	
		81 - 90	Normal mode	
		91 - 100	High Pattern	
		101 - 110	NO function	
		111 - 120	NO function	
		121 - 130	NO function	
		131 - 140	NO function	
		141 - 150	NO function	
		151 - 160	NO function	
		161 - 170	NO function	
		171 - 180	Show backlight is always on	
181 - 190	Display backlight automatically			
191 - 200	Open the function			
201 - 255	NO function			
7	Cyan	0 - 255		
8	Cyan fine	0 - 255		
9	Magenta	0 - 255		
10	Magenta fine	0 - 255		
11	Yellow	0 - 255		
12	Yellow fine	0 - 255		
13	CTO	0 - 255		
14	CTO fine	0 - 255		
15	Colour wheel	0 - 89	0 - 360°	
		90 - 99	OPEN	
		100 - 109	COLOR1	
		110 - 119	COLOR2	
		120 - 129	COLOR3	
		130 - 139	COLOR4	
		140 - 149	COLOR5	
		150 - 159	COLOR6	
		160 - 169	COLOR7	
		170 - 179	COLOR8	
		180 - 214	CW, Slow→Fast	
		215 - 249	CCW, Fast→Slow	
250 - 255	Random color			
16	Static Gobo	0 - 9	OPEN	
		10 - 19	GOB01	
		20 - 29	GOB02	
		30 - 39	GOB03	
		40 - 49	GOB04	
		50 - 59	GOB05	
		60 - 69	GOB06	
		70 - 79	GOB07	
		80 - 89	GOB08	
		90 - 99	GOB09	
		100 - 109	GOB01 Jitter slow to fast	

Channel	DMX	Percentage	Functions	Note
		110 - 119	GOB02 Jitter slow to fast	
		120 - 129	GOB03 Jitter slow to fast	
		130 - 139	GOB04 Jitter slow to fast	
		140 - 149	GOB05 Jitter slow to fast	
		150 - 159	GOB06 Jitter slow to fast	
		160 - 169	GOB07 Jitter slow to fast	
		170 - 179	GOB08 Jitter slow to fast	
		180 - 189	GOB09 Jitter slow to fast	
		190 - 199	OPEN	
		200 - 224	CW, Slow→Fast	
		225 - 249	CCW, Fast→Slow	
		250 - 255	Random Gobo	
		17	Rot. Gobo	0 - 9
10 - 19	GOB01			
20 - 29	GOB02			
30 - 39	GOB03			
40 - 49	GOB04			
50 - 59	GOB05			
60 - 69	GOB06			
70 - 79	GOB07			
80 - 89	GOB01 Jitter slow to fast			
90 - 99	GOB02 Jitter slow to fast			
100 - 109	GOB03 Jitter slow to fast			
110 - 119	GOB04 Jitter slow to fast			
120 - 129	GOB05 Jitter slow to fast			
130 - 139	GOB06 Jitter slow to fast			
140 - 149	GOB07 Jitter slow to fast			
150 - 159	OPEN			
160 - 204	CW, Slow→Fast			
205 - 249	CCW, Fast→Slow			
250 - 255	Random Gobo			
18	Gobo Rot.			0 - 127
		128 - 187	CW Fast→Slow	
		188 - 195	STOP	
		196 - 255	CCW Slow→Fast	
19	Prism1	0 - 10	Prism off	
		11 - 255	Prism Cut-in	
20	Prism1 Rot	0 - 127	0° - 360°	
		128 - 187	CW Fast→Slow	
		188 - 195	STOP	
		196 - 255	CCW Slow→Fast	
21	Prism2	0 - 10	Prism off	
		11 - 255	Prism Cut-in	
22	Prism2 Rot.	0 - 127	0° - 360°	
		128 - 187	CW Fast→Slow	
		188 - 195	STOP	
		196 - 255	CCW Slow→Fast	
23	Frost1	0 - 127	Minimum to maximum atomization	
		128 - 159	Slow IN Fast OUT, Slow → Fast	
		160 - 191	Fast IN Slow OUT, Slow → Fast	
		192 - 255	Slow IN Slow OUT, Slow → Fast	
24	Frost2	0 - 127	Minimum to maximum atomization	
		128 - 159	Slow IN Fast OUT, Slow → Fast	
		160 - 191	Fast IN Slow OUT, Slow → Fast	
		192 - 255	Slow IN Slow OUT, Slow → Fast	

Channel	DMX	Percentage	Functions	Note
25	Zoom			
26	Zoom fine	0 - 255		
27	Focus	0 - 255		
28	Focus fine	0 - 255		
29	Auto Dis.	0 - 9	NO function	
		10 - 19	5M	
		20 - 29	10M	
		30 - 39	15M	
		40 - 49	20M	
		50 - 59	30M	
		60 - 255	40M	
30	Auto Fin	0 - 255		
31	Strobe	0 - 255		
32	Dimmer	0 - 255		
33	Dimmer fine	0 - 255		

CIRCUIT CONNECTING DIAGRAM

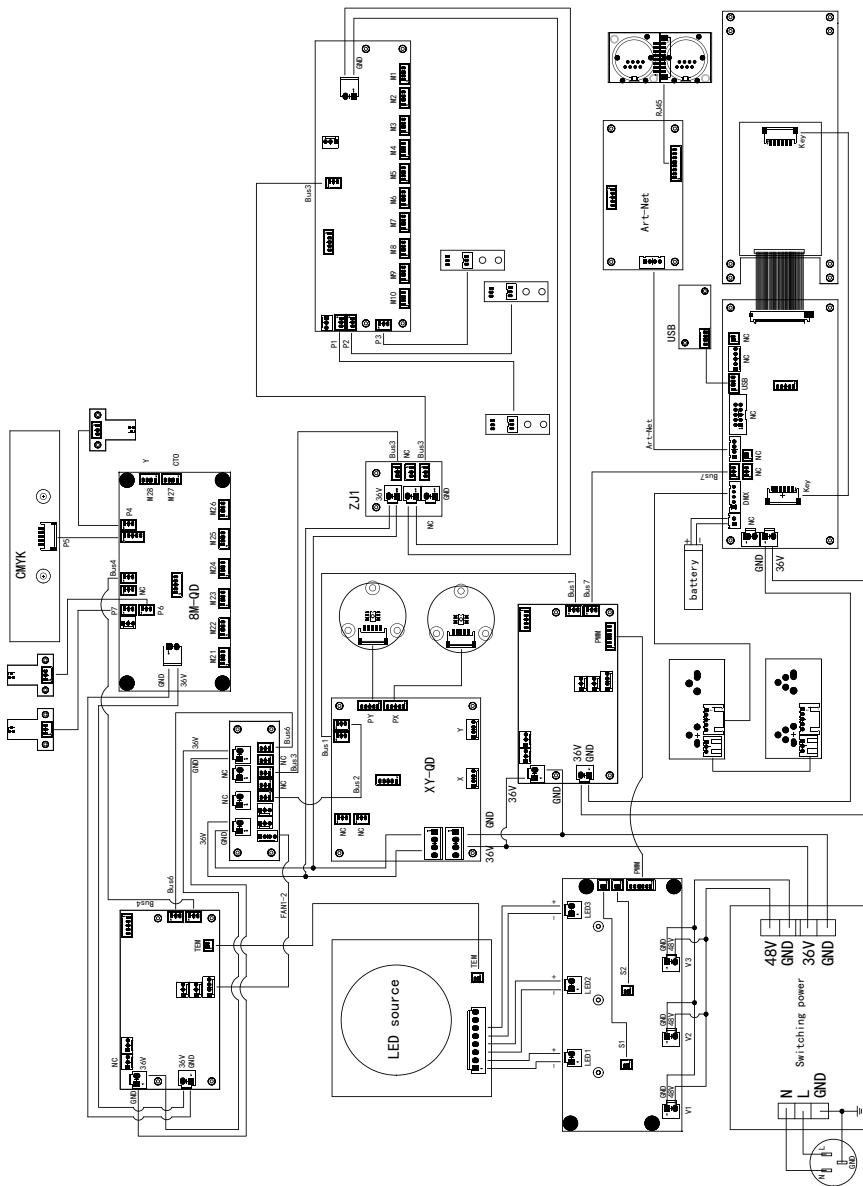

CLEANING AND MAINTENANCES

- 1. In order to ensure the fixture could work normally. It should be kept clean always .
The lens should also be regularly cleaned to maintain an optimum light output.
Do not use any type of solvent on lens. It will damage the fixture.

- 2. Suggestion: The continue usage of the light don't exceed 4 hours. Or it will shorter the usage of the lamp. Please use the alternative operation to solve this problem.
The fixture power ON time is best not over 48 hours, or it would generate lamp protection procedure.

- 3. Please disconnect the power supply when begin to maintenance take down the fixture.
Please let the parts cool down 10 minute at least then begin to install.

- 4. Please inspect the lens or other moving parts timing and keep them clear and static.
If find anything damaged or looseness must change a lamp or fix the lamp in order to avoid the accident.

Please check the machanical parts is jamging. After cleaning, please add some temperature -durable juice.

- 5. The fixture use the strong cool system. It is easy for the dirty to be colleted. Please do clear the hot-sak one time two week at least.

- 6. After you use the fixture, please check the intake place whether there are some wastepaper, please clean it up, or the windmill will break down and causing fire.

CAUTION!!!

Disconnect from mains before starting maintenance operation!

TROUBLESHOOTING

It is recommended some solution for some normal trouble shooting. Any inextricability problems should always be handling by the professional person. Disconnect the power supply before maintenance the fixture.

■ LED off :

- 1.Please check if install the suitable voltage
- 2.Please check whether the led will reach the end of their life can explode; please replace a same description led.
- 3.Please check if the power supply is enough.
- 4.Please check whether the DMX 512 controller pass the "turn on" order.

■The fixture couldn't accept the control order:

- 1.Please check the start code address and the function option are correct.
- 2.Please check whether the communicate control cable is on good connection or the cable is too long or interrupt.
- 3.Please check the control system is not valid, check the signal amplifier of chain connected is valid.
- 4.Please check whether the communicate cable is too long or the other equipment is mutually conjugate.
- 5.Please arrange the wire well, shorter the signal cable, put the high voltage cable and low voltage cable separately.
- 6.Add the signal amplify isolator.
- 7.Signal cable is used the excellent screening doublet (Resistance 75 OHM)
- 8.The end of the light end and the end resistance.

■The fixture can't move:

- 1.Please check if the power supply is suitable for the light voltage data.
- 2.Please check the light if they are deformation, inside parts is broken, become wet etc will lead the loose contact.
- 3.Please check the if the inside lead wire and the connector is loose.
- 4.Please check the electric parts(such as the transformer,PCB board,contrller) is short-circuit or burn down.

- The light beam dark, not inhomogeneous.
 - ⊙ when the light source is to the usage life, the light source is not enough, please change a new one for the same description.
 - ⊙ Please check the reflector parts is dirty. Keep them clear.
 - ⊙ Please measure if the power supply is enough.
 - ⊙ Enter the menu "service options" to choose "calibration" to enter the "Color" and "Gobo" adjustment, the center can be modulated.

- The fixture shadow is fogging.
 - ⊙ Please check the data on the DMX 512 controller is suitable for the electric focus.
 - ⊙ Please check the mechanical parts is jamming. After cleaning, please add some temperature -durable grease.

- Part of the fixture couldn't respond to the controlling order:
 - ⊙ Please check the order is correct to the moving .
 - ⊙ Please check the mechanical part is deformation or loose.
 - ⊙ Please check the function to the motor socket is loose or drive chip is burn down;
 - ⊙ Please check the wire of the motor is cut at zig point;
 - ⊙ Please check these function to the motor is damaged.

- On working, the pan & tilt couldn't work normally:
 - ⊙ Please check according to the above step by step ;
 - ⊙ Please check the belt of the pan & tilt is broken;
 - ⊙ Please check the pan & tilt direction data to the receiver is damage;
 - ⊙ Restart the fixture and reset

DUTY EXONERATIVE AND COPYRIGHT PROTECTION

- ◆The light source belongs to consumption products that is not guarantee to keep it in good repair.
- ◆Any products broken that didn't according to the instruction is not guarantee to keep it in good repair.
- ◆The commentary for all the instruction belongs to the supplier in final.
- ◆No authorize can't copy.
- ◆The information in this manual may be changed in the future,the company reserve the right to change the data without any advise.