

LIGHT SKY[®]

FLY DRAGON LIGHTING EQUIPMENT CO.,LTD

MAMBA

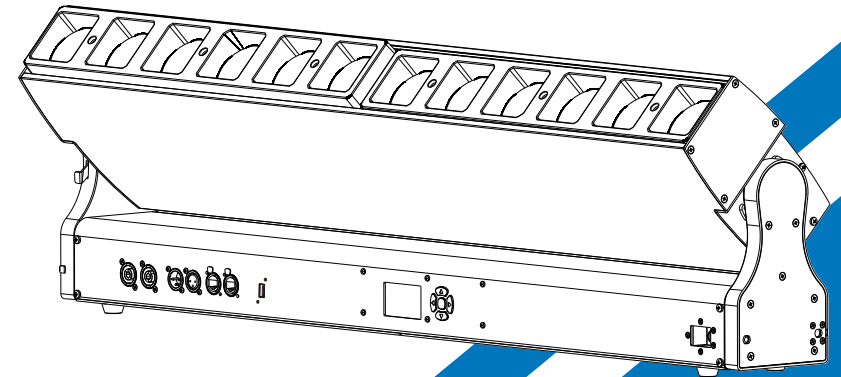

LIGHT SKY[®]

Tel:0086-20-61828288

Fax:0086-20-61828188 Pc:510800

Web:www.lightsky.com.cn

E-mail: flydragon@lightsky.com.cn

asia@lightsky.com.cn

india@lightsky.com.cn

europa@lightsky.com.cn

latinamerica@lightsky.com.cn

middle-east@lightsky.com.cn

american@lightsky.com.cn

Address: No. 43, Yunfeng Road, Xiuquan Street,
Huadu District, Guangzhou, China



LIGHT SKY[®]



WWW.LIGHTSKY.COM.CN

User Manual

Please read the instruction carefully before use

CONTENTS

1、 Safety Instructions	2
2、 Technical Specifications	5
2.1、 Attachment And Size	7
3、 Control Panel	8
4、 How To Set The Unit.....	9
4.1、 Main Function.....	9
5、 Connection and control	20
5.1、 Power supply connection.....	20
5.2、 DMX 512 Connection.....	21
5.3、 Channel Setting.....	22
5.4、 Address Setting.....	22
5.5、 DMX 512 Configuration	23
6、 Electrical Connection Diagram	26
7、 Troubleshooting.....	27
8、 Fixture Cleaning.....	28
9、 Duty exonerative and copyright protectio	28

Congratulations on choosing our company product! We thank you for your custom.

- ◆ Please keep in mind that this product, like other products of the company, adheres to the concept of people-oriented design and manufacture, and takes product quality as the foundation.
- ◆ We put the interests of customers first, and do our best to meet customer requirements.
- ◆ Please read this instruction manual carefully and keep it for future reference. In the case of fully understanding the product information, strictly abide by theUse the instruction manual to ensure that the product is installed, used and serviced correctly and safely.
- ◆ Our company is not responsible for any damage to lamps or other performance due to personal failure to follow the instructions during installation, use and maintenance.responsibility.
- ◆ Our company reserves the right to modify the manual at any time and without prior notice.

1.Safety Instructions



Please read the instruction carefully which includes important information about the installation, usage and maintenance.

WARNING

Please keep this User Manual for future consultation. If you sell the unit to another user, be sure that they also receive this manual.

The following symbols are used to identify important safety information on the product and in this manual:

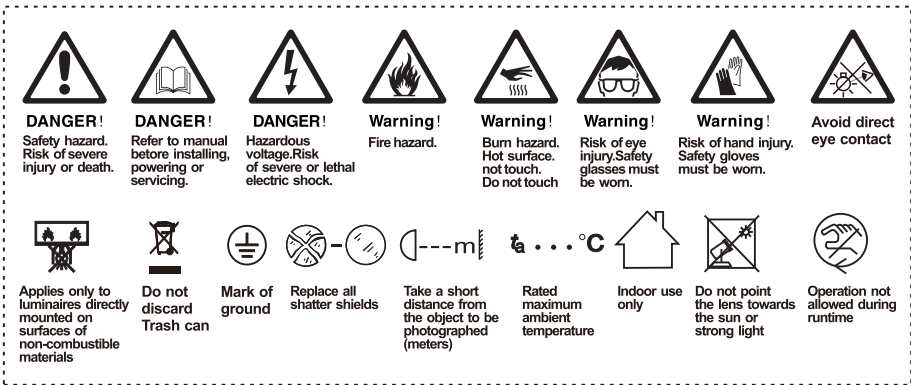

Important:

Damages caused by the disregard of this user manual are not subject to warranty.

The dealer will not accept liability for any resulting defects or problems.

- The equipment is only suitable for indoor dry place use.
- Unpack and check carefully to ensure that there is no transportation damage before using the unit.
- Do install and operate by qualified operator.
- The light source in this luminaire should be replaced by the manufacturer or its service agent or a similarly qualified person, always cut off the power supply before replacing the light source.
- Do not allow children to operate the fixture.
- Use safety chain when fixing the unit. Handle the unit by carrying its base instead of head only.

- The unit must be installed in a location with adequate ventilation, at least 20cm from adjacent surfaces.
- Be sure that no ventilation slots is blocked, otherwise the unit will be overheated.
- Before operation, ensure that you are connecting this product to the proper voltage in accordance with the specifications in this manual or on the product's specification label.
- It's important to ground the yellow/green conductor to earth in order to avoid electric shock.
- Minimum ambient temperature Ta: -10°C. Maximum ambient temperature Ta: 45°C.
Do not operate this product at a lower or higher temperature.
- Do not connect the device to any dimmer pack.
- When the lamp is running, do not place combustible objects next to it. The shortest distance between the device and inflammable and explosive objects or materials is 0.5m.
- Make sure the power cord is not crimped or damaged; replace it immediately if damaged.
- Unit's surface temperature may reach up to 80°C. do not touch the housing bare-handed during its operation.
- Avoid any flammable liquids, water or metal from entering the unit. Once it happens, cut off the mains power immediately.
- Do not operate in a dirty or dusty environment. do clean the fixture regularly.
- Do not touch any wire during operation as there might be a hazard of electric shock.
- Avoid entanglement of the power cord with other wires.
- The minimum distance to objects/surface must be more than 3 meters.
- In the event of serious operating problem, stop using the unit immediately.
- Never turn on and off the unit time after time.
- The housing, the lenses, or the ultraviolet filter must be replaced if they are visibly damaged.
- Do not open the housing as there are no user serviceable parts inside.
- Do not attempt to operate this unit if it becomes damaged. do not attempt any repairs yourself. Repairs carried out by unskilled people can lead to damage or malfunction. Please contact the nearest authorized technical assistance center if needed.
- Disconnect this product from its power source before servicing.
- Do use the original packaging if the device is to be transported.
- Avoid direct eye exposure to the light source while the product is on.

- Do not operate this product if you see damage on the housing, shields, or cables. Have the damaged parts replaced by an authorized technician at once.

Installation:

The fixture should be fixed on the clamp. always ensure that the unit is firmly fixed to avoid vibration and slipping off during operation. ensure that the trussing or area of installation must be able to hold 10 times the weight without any deformation. Always install a safety cable that can hold at least 12 times the weight of the fixture when installing.do install and operate by qualified operator. It must be installed in a place where there is out of the reach of people.

2. Technical Specifications

OPTICS

- Light source: 12*40W LED chip RGBW 4 in 1
- Beam angle: 3.6°-38°
- Zoom angle: 4.2°-53°
- Color Temperature: 2200K-8000K
- Light Luminous Flux: 18460 lux@5 meters

EFFECT

- Color Mixing System: uniform RGBW color mixing and rainbow effect
- Zoom system: Linear electronic zoom
- Individual Controlled: support individual controlled, varied in color and effect
- effect macro: static and dynamic
- Dimmer: Linear electronic dimmer, provides four dimming options
- Strobe: 1-30Hz electronic strobe and random strobe

CONTROL AND PROGRAMMING

- Controlled Channel: 19CH(Standard), 64CH(Extended), see channel table for details
- Control Mode: DMX512, RDM, ART-NET
- Data connection: RJ45 input and output, 3-pin and 5-pin input and output
- Display: LCD Lattice screen

SOFTWARE

- Upgrade: Upgrade software through DMX signal interface and USB interface
- Intelligent temperature control to ensure long lifespan of LED

PAN/TILT MOVEMENT

- Tilt movement: 185° 16 bit precision

POWER AND VOLTAGE

- Input voltage: AC 100-240V 50/60Hz
- Power: 425W PF: > 0.98

SIZE AND WEIGHT

- Light Size: 1003mm×126mm×308mm
- N.W: 20.3 kg
- Carton size: 1110mm×410mm×215mm
- G.W: 24.0 kg
- Flycase (option-3 sets) : 1075mm×680mm×495mm
- N.W: 60.9 Kg G.W: 100.4 Kg

OTHERS

- IP rate: IP20
- Working environment: $-10^{\circ}\text{C} \sim 45^{\circ}\text{C}$
- Maximum temperature of fixture body surface: 80°C
- Maximum on-line quantity: 2pcs/110V 4pcs/220V
- Maximum current: 1.9A/220V; 4.3A/110V
- Optional material: light hook

APPROVALS

- The product implementation standard: GB 7000.1-2015 GB7000. 217-2008
- Approved certifications: CE、RoHs
- The product complies with the following EU directives:
- Low Voltage Directive 2014/35/EU . EMC Directive 2014/30/EU

illumination diagram

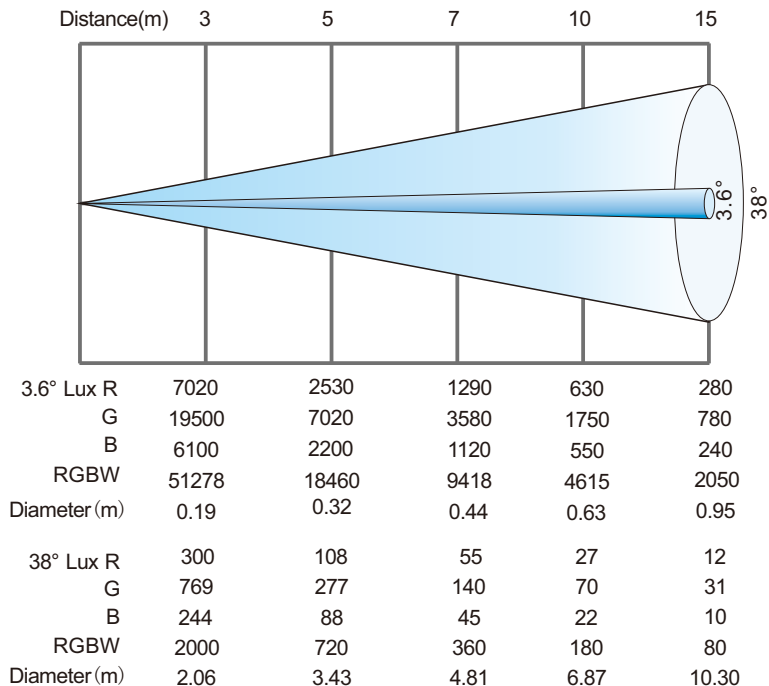

LED Chips Sequence

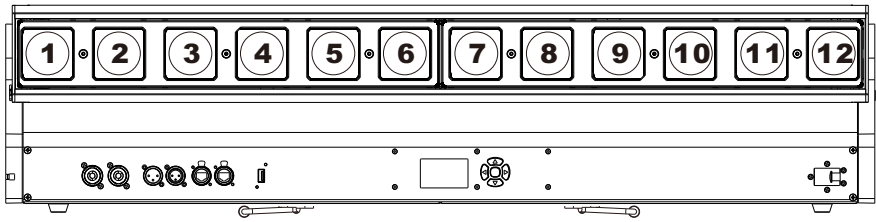

2.1.Attachment And Size

Attachment contents-Fig.1

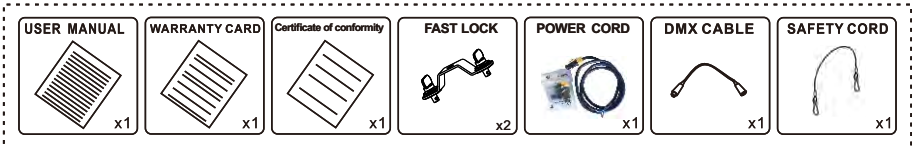

Size-Fig.2

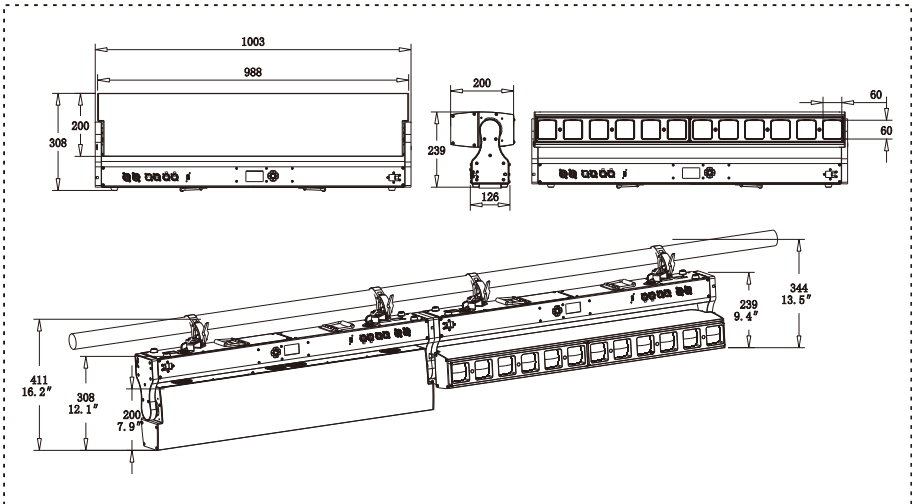

3.Control Panel

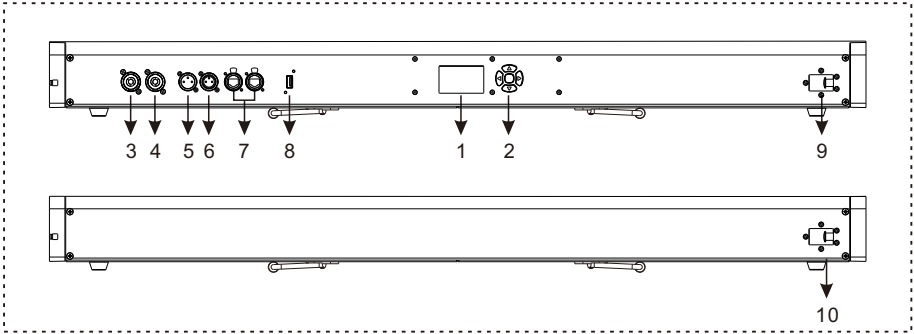

1. Display: To show the various menus and the selected function.
2. Button:

●	OK confirmation key
▲	UP
▼	DOWN
◀	To the left
▶	To the right

3. Power input: connect to the power supply.
4. Power output: connect to the lamp power output adapter.
5. DMX input: for DMX512 connection, use 3 or 5-core XLR signal cable to connect console and lamps,and input DMX signal.
6. DMX output: used for DMX512 connection, use 3 or 5-core XLR signal cable to connect console and lamps,And output DMX signal.
7. ART-NET input/output: The information of the luminaire can be transmitted to the main controller through the network cable, and the luminaire can be controlled through Rj45.
8. USB socket: for updating software version.
9. Lamp connection lock position (front)
10. Lamp connection lock position (back)

4.How To Set The Unit

4.1.Main Function

After starting up, press any key to enter the **preset menu** interface, use the up/down/left/right keys to select: DMX settings, basic information, personality settings, manual control, service options, test lamps, language, screen rotation, press OK Confirm and enter the lower menu.

① – DMX settings

Enter the **Preset menu** interface, select  Function, press the OK key to enter the lower menu, use the Up/Down key to select the ② level menu: DMX address, signal priority, AreNet setting, exit.

② **DMX address:**

Select the **DMX address** function, press the OK key to enter the lower-level menu, press the up/down key, you can choose to set the address code (001~512) of the lamp according to the current channel mode, and press the left/right key to fine-tune the address code. Press OK to confirm the settings and return to the previous menu.

② **DMX/Artnet:**

Select the **DMX/Artnet** function, press the OK button to enter the lower menu, press the up/down button, you can choose: DMX priority (default), ARTNET priority, press the OK button to confirm the setting and return to the upper menu, or press the left/right button to Returns to the previous menu without changing the current selection.

② **ArtNet Set:**

Select the **ArtNet Set** function, press the OK key to enter the lower-level menu, press the Up/Down key to select: IP address, Mask address, Net address, Sub Net address, Universe address, and exit. Press the OK key to enter the lower level menu, or press the left/right key to return to the upper level menu.

③ **IP address:**

Select the **IP address** function, press the OK key to enter the sub-menu, press the left/right key to select the address code number segment to be set, and press the up/down key to adjust the number of the number segment. Press OK to confirm the settings and return to the previous menu.

③ **Mask address:**

Select the **Mask address** function, press the OK key to enter the lower-level menu, press the left/right key to select the address code number segment to be set, and press the up/down key to adjust the number of the number segment. Press OK to confirm the settings and return to the previous menu.

③ **Net address:**

Select the **Net address** function, press the OK key to enter the submenu, and press the Up/Down key to adjust the Net address code (001~128). Press OK to confirm the settings and return to the previous menu.

③ **Sub Net address:**

Select the **Sub Net address** function, press the OK key to enter the sub-menu, and press the Up/Down key to adjust the Sub Net address code (001~015). Press OK to confirm the settings and return to the previous menu.

③ **Universe address:**

Select the **Universe address** function, press the OK key to enter the submenu, and press the Up/Down key to adjust the universe address code (001~015). Press OK to confirm the settings and return to the previous menu.

① – **Information**

Enter the **preset menu** interface, select  function, press the OK key to enter the lower menu, use the up/down keys to select the ② level menu: total running time, equipment time, equipment temperature, RDM address, fan voltage, equipment channel, version information, quit.

② **Total Time**

Select the **Total Time** function of total running time, press the OK key to enter the sub-menu, and you can view the equipment: always powered on (H), always on (H). Press OK or Left/Right to return to the previous menu.

② **Led hours**

Select the **Led hours** function, press the OK key to enter the sub-menu, you can view the device: power-on time (H), lighting time (H). Press OK or Left/Right to return to the previous menu.

② **Temperature**

Select the **Temperature** function, press the OK key to enter the lower-level menu, and you can view the temperature of the device: driver board 1, light source 1, driver board 2, and light source 2 (unit: °C). Press OK or Left/Right to return to the previous menu.

② **RDM UID**

Select the **RDM UID** function, press the OK key to enter the submenu, and you can view the device: RDM address information. Press OK or Left/Right to return to the previous menu.

② **Fan voltage**

Select the **Fan voltage** function, press the OK key to enter the sub-menu, you can view the equipment: cooling fan 1, cooling fan 2 voltage. Press OK or Left/Right to return to the previous menu.

② **DMX live**

Select the **DMX live** function, press the OK key to enter the submenu, and you can view the device: channel information in the current channel mode. Press OK or Left/Right to return to the previous menu.

② **System version**

Select the **System version** function, press the OK key to enter the lower-level menu, and you can view the version information of the device: display board, Y-axis board, zoom 1, zoom 2, light board 1, and light board 2. Press OK or Left/Right to return to the previous menu.

① - **Personal**

Enter the **preset menu** interface, select  function, press the OK button to enter the lower menu, use the up/down button to select the ② level menu: channel mode, interface display password, dimming curve, LED sequence reverse, display setting, Led frequency setting, Fan mode, exit, press OK key to enter the lower menu, or press the left/right key to return to the upper menu.

② Channel mode

Select the **Channel mode** function, press the OK key to enter the lower menu, you can use the up / down keys to select: standard mode (19CH) (default), extended mode (64CH), press the OK key to confirm the selection and return to the upper menu.

② Display lock

Select the **Display lock** function, press the OK key to enter the submenu, press the up/down key to select: on, off (default), press the OK key to confirm Select and return to the previous menu. (Note: The interface password function only works for the DMX setting function, password: 2222)

② Dimmer Curve

Select the **Dimmer Curve** function, press the OK key to enter the lower menu, you can use the Up/Down keys to select: linear (default), square curve, inverse square curve, S curve, press the OK key to confirm the selection and return to the upper menu.

Dimmer Modes

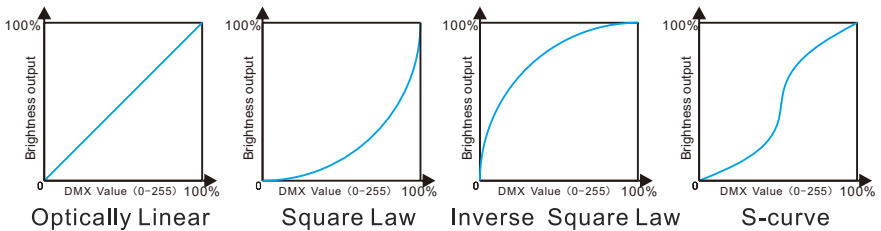

② LED sequence reverse

Select the **LED sequence reverse** function of setting the sequence of light beads in reverse, press the OK key to enter the lower menu. You can use the up/down keys to select: close/open, press the OK key to confirm the selection and return to the upper menu.

② Display

Select the **Display** setting function, press the OK key to enter the submenu, you can use the up/down key to select the ③ level menu: language (Language), backlight, screen rotation, backlight flashing, exit, press the OK key to enter the submenu, or press the left button Return to previous menu.

③ Language

Select the **Language** function, press OK key to enter the lower menu, you can use the up / down keys to select: English , Chinese (default), press OK key to confirm the selection and return to the upper menu.

③ Backlight

Select the **Backlight** function, press the OK key to enter the lower menu, you can use the up/down keys to select: constant light, automatic off (30S) (default), press the OK key to confirm and return to the upper menu.

③ Reversal

Select the **Reversal** function, press the OK key to enter the lower menu, you can use the up / down keys to select: normal (default), rotate 180 degrees, press the OK key to confirm and return to the upper menu.

③ Backlight blink

Select the **Backlight blink** function, press the OK key to enter the submenu, you can use the up / down keys to select: open (default), close, press the OK key to confirm and return to the previous menu.

② Led Preq Set

Select the **Led Preq Set** function, press the OK button to enter the lower menu, you can use the up/down button to select the ③ level menu: 1000 Hz, 3600 Hz, 7200 Hz, 25000 Hz (default), press the OK button to confirm the selection and return to the upper menu, Pressing Left/Right only returns to the previous menu without changing the current selection.

② Fan mode

Select the fan mode function, press the OK key to enter the lower-level menu, you can use the up/down keys to select the ③ menu: high speed, silent, press the OK key to confirm the selection and return to the upper-level menu, press the left/right key to only return to the upper-level menu, not Change the current selection.

② Dimming mode

Select the dimming mode function, press the OK key to enter the lower menu, and use the up/down keys to select the ③ level menu: fast and smooth, press the OK key to confirm the selection and return to the upper menu, press the left/right keys to only return to the upper menu, without changing the current selection.

① - Manual control

Enter the **preset menu** interface, select  function, press the OK key to enter the submenu, you can use the up/down key to select the ② level menu: channel control, reset, exit, press the OK key to enter the submenu, or press the left/right key to Return to previous menu.

② Channel control

Select the **Channel control** function, press the OK key to enter the sub-menu, press the up / down key to select each channel of the current channel mode, press the left / right key to manually adjust the DMX value of each channel from 0 to 255, press the OK key Return to the previous menu, and at the same time, the lamp is reset to the state just turned on.

② Reset

Select the **Reset** function, press the OK key to enter the lower menu, you can use the up / down keys to select: system reset (that is, the whole machine reset), vertical reset, zoom reset, exit, press the OK key to confirm and execute the selected reset command, and return Previous menu, or press Left/Right to return to previous menu only.

① - Service

Enter the **preset menu** interface, select  function, press the OK key to enter the submenu, you can use the up/down key to select: current fault information, clear fault information, calibration, factory settings, exit, press the OK key to enter the submenu, or press the Left/Arrow only returns to previous menu.

② Error list

Select the **Error list** function, press the OK key to enter the lower-level menu, you can view the fault records of the whole machine, press the OK key or the left/right key to return to the upper-level menu.

② Clean error

Select the **Clean error** function, press the OK key to enter the lower menu, use the up/down keys to select: no clear (default), clear, you can clear or keep the fault records of the lamp, press the OK key to confirm clearing the fault information and return to the upper menu , or press Left/Right to return to the previous menu without changing the current selection.

② Calibration

Select the **Calibration** function, press the OK key to enter the lower menu, press the up/down key to select each channel of the current channel mode, press the left/right key to manually fine-tune the DMX value of each channel from 0 to 255 (default 128), press OK key to confirm and return to the previous menu.

② Factory

Select the **Factory** function, press the OK key to enter the submenu, you can use the up / down keys to select: factory default, time clear, developer, software upgrade, exit, press the OK key to enter the submenu. Note that the functions under this menu require a password to proceed to the next step.

① - Test

Enter the **preset menu** interface, select  function, press the OK key to enter the submenu, you can use the up/down key to select: test vertical, test the head effect, overall test, exit, press the OK key to enter the submenu, and the lamp starts to execute Test instructions. Or press Left/Right to return to previous menu only.

① - Language

Enter the **Preset Menu** interface, select  Function, and press OK to switch between Chinese (default) and English.

① - Reversal

Enter the **Preset Menu** interface, select  Function, and press OK to switch the screen between: normal and rotated 180 degrees.

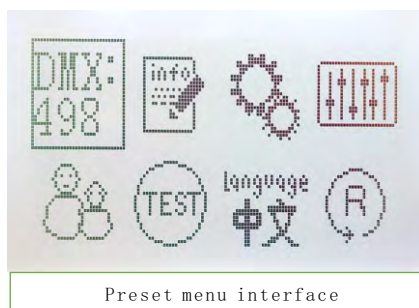

Main menu	I menu	II menu	III menu	IV menu	
DMX Address	Address:001-512				
	DMX/ARTNET	DMX Priority			
		ARTNET Priority			
	ArtNet Set	IP Address	→ xxx. xxx. xxx. xxx		
		Mask Address	→ xxx. xxx. xxx. xxx		
		Net Address	→ 1-128		
Sub Net Address		→ 0-15			
Universe Address	→ 0-15				
Return(ESC)					
Information	Total Time	Power:****(h)			
		Led ON:****(h)			
	Led hours	Total:****(h)			
		Led open:****(h)			
	Temperature	Borad 1: 00.0			
		LED 1: 00.0			
		Borad 2:00.0			
		LED 2:00.0			
	RDM UID	→ RDM UID 3888:00000000			
	FanVotag	LEDFan1 00.0V			
		LEDFan2 00.0V			
	DMX live	1. Dimmer 000-255			
		2. DimmerFine 000-255			
		3. strobe 000-255			
		4. Red 000-255			
		5. Green 000-255			
		6. Blue 000-255			
		7. White 000-255			
		8. CCT 000-255			
		9. Inter Program 000-255			
10. Program Speed 000-255					
11. Dimmer of Back Color (for Program) 000-255					
12. Red of Back Color (for Program) 000-255					
13. Green of Back Color (for Program) 000-255					
14. Blue of Back Color (for Program) 000-255					
15. White of Back Color (for Program) 000-255					
16. ZOOM left segment 000-255					
17. TILT 000-255					
18. TILT FINE 000-255					
19. RESET 000-255					
System version	Display				
	Y Board				
	Zoom1				
	Zoom2				
	LED1				
LED2					
Return(ESC)					
Channel mode	Standard(19CH)				
	Extended(64CH)				
Display lock	OFF				
	ON				

Main menu	I menu	II menu	III menu	IV menu
Personal	Dimmer Curve	Linear (Default)		
		Square		
		I-Square		
		SCurve		
	LED invert	OFF		
		ON		
	Display	Language	English	
			Chinese	
		BackLight	Open	
			Auto close(30s)	
		Reversal	Normal	
			Rota.180	
	Backlight blink	ON		
		OFF		
		Return(ESC)		
	Led Preq Set	1000 Hz		
		3600 Hz		
7200 Hz				
25000 Hz				
Fan mode	fast			
	silence			
Dim mode	fast			
	smooth			
	Return(ESC)			
Manual control	Channel control	1. Dimmer 000-255		
		2. DimmerFine 000-255		
		3. strobe 000-255		
		4. Red 000-255		
		5. Green 000-255		
		6. Blue 000-255		
		7. White 000-255		
		8. CCT 000-255		
		9. Inter Program 000-255		
		10. Program Speed 000-255		
		11. Dimmer of Back Color(for Program) 000-255		
		12. Red of Back Color(for Program) 000-255		
		13. Green of Back Color(for Program) 000-255		
		14. Blue of Back Color(for Program) 000-255		
		15. White of Back Color(for Program) 000-255		
		16. ZOOM left segment 000-255		
		17. TILT 000-255		
		18. TILT FINE 000-255		
		19. RESET 000-255		
		Return(ESC)		
	Reset	system reset		
Tilt reset				
Zoom reset				
Return(ESC)				
	Return(ESC)			
Error list	ZOOM1			
	ZOOM2			
	TILT			

Main menu	I menu	II menu	III menu	IV menu	
Service	Clean error	Yes			
		No		(code: 2222)	
	Calibration	Tilt	000-255		
		Zoom1	000-255		
		Zoom2	000-255		
		Red1	000-255		
		Green1	000-255		
		Blue1	000-255		
		White1	000-255		
		Red2	000-255		
		Green2	000-255		
		Blue2	000-255		
		White2	000-255		
		Red3	000-255		
		Green3	000-255		
		Blue3	000-255		
		White3	000-255		
		Red4	000-255		
		Green4	000-255		
		Blue4	000-255		
		White4	000-255		
		Red5	000-255		
		Green5	000-255		
		Blue5	000-255		
		White5	000-255		
		Red6	000-255		
		Green6	000-255		
		Blue6	000-255		
		White6	000-255		
		Red7	000-255		
		Green7	000-255		
		Blue7	000-255		
	White7	000-255			
Red8	000-255				
Green8	000-255				
Blue8	000-255				
White8	000-255				
Red9	000-255				
Green9	000-255				
Blue9	000-255				
White9	000-255				
Red10	000-255				
Green10	000-255				
Blue10	000-255				
White10	000-255				
Red11	000-255				
Green11	000-255				
Blue11	000-255				
White11	000-255				
Red12	000-255				
Green12	000-255				
Blue12	000-255				
White12	000-255				

Main menu	I menu	II menu	III menu	IV menu	
	Factory →	Return(ESC)			
		Default			
		Time clean	Total Time		
			Device Time		
			Led Time		
		Developer →	Manual OR DMX →	DMX Control	
				Manual Control	
			Load font →		
			LOGO select →	LIGHT SKY	
				Custom LOGO	
			LOGO upgrade →	No LOGO	
		Return(ESC) →			
		Firmware update			
		Return(ESC)			
Return(ESC)					
test →	Test T →	STEP ***			
	Test effect →	STEP ***			
	Test all →	STEP ***			
	Return(ESC)				
Language →	English				
	Chinese				
Reversal →	Normal				
	Rota. 180				

5.Connection and control

5.1.Power supply connection

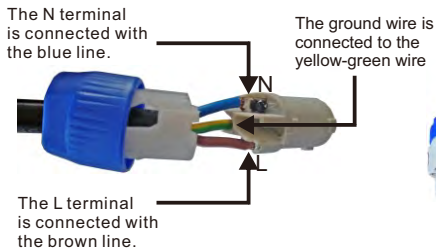
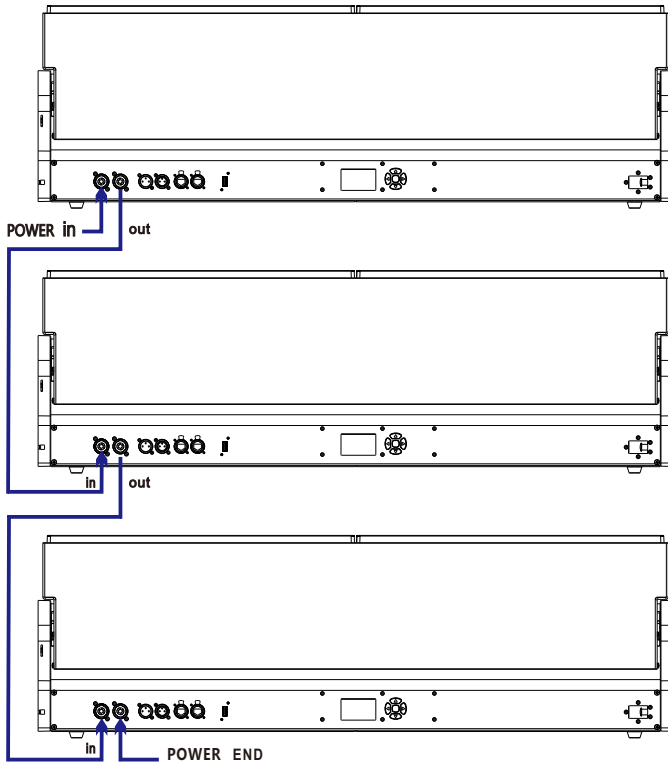

- The bus connecting the power supply must be installed by a qualified professional technician.
- After completing all the above operations and ensuring that it is installed, you can power on the lamp to operate.

5.2.DMX 512 Connection

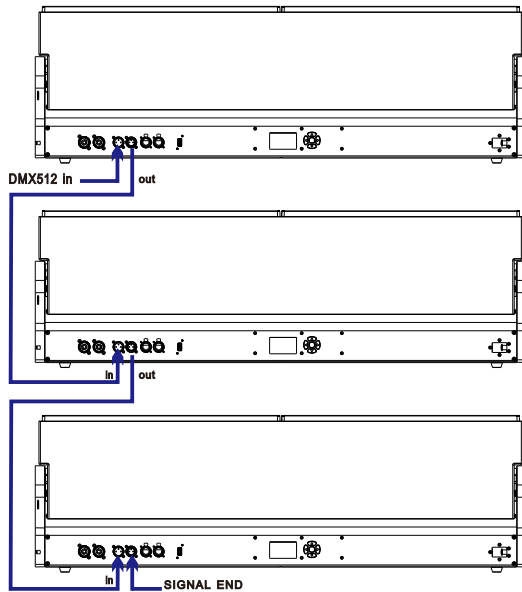

DMX-input

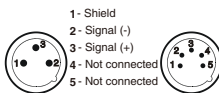

DMX - output

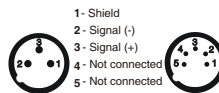

1. At last unit, the DMX cable has to be terminated with a terminator. Solder a 1200hm 1/4W resistor between pin 2(DMX-) and pin 3(DMX+) into a 3-pin XLR-plug and plug it in the DMX-output of the last unit.
 2. Connect the unit together in a "daisy chain" by XLR plug cable from the output of the unit to the input of the next unit. The cable cannot be branched or split to a "Y" cable. DMX 512 is a very high-speed signal. Inadequate or damaged cables, soldered joints or corroded connectors can easily distort the signal and shut down the system.
 3. The DMX output and input connectors are pass-through to maintain the DMX circuit, when one of the units' power is disconnected.
 4. Each lighting unit needs to have a DMX address to receive the data by the controller. The address number is between 1-512.
 5. The end of the DMX 512 system should be terminated to reduce signal errors.
 6. 3 pin XLR connectors are more popular than 5 pins XLR.
- 3 pin XLR: Pin 1: GND, Pin 2: Negative signal (-), Pin 3: Positive signal (+)
5 pin XLR: Pin 1: GND, Pin 2: Negative signal (-), Pin 3: Positive signal (+), Pin4, Pin5 not used.

5.3.Channel Setting

Enter the MENU menu, select the Personal Settings function, select the channel mode, press the OK button to confirm, you can use the up and down keys to select: 19channels (default), 64 channels, Press the OK key to enter the selection confirmation and return to the previous menu.

5.4.Address Setting

Enter MENU, select the DMX setting function, select the address code setting, press the OK button to confirm, the current DMX address will be displayed on the display. Use the up/down buttons to select addresses 001~512, and press the OK button to save. Press the OK button to return to the previous menu.

Please refer to the following diagram to address your DMX512 channel for the first 4 units.

Channel mode	Unit 1 Address	Unit 2 Address	Unit 3 Address	Unit 4 Address
19 CH	1	20	39	58
64 CH	1	65	129	193

5.5.DMX 512 Configuration

64 Channel	19 Channel	DMX	Function	Note
1	1	0-255	Dimmer Light output linearly increase from off to maximum brightness	
2	2	0-255	Dimmer Fine Fine Dimmer positioning	
3	3	0 - 9 10 - 194 195 - 199 200 - 249 250 - 255	Strobe Close Strobe from slow to fast Open Random strobe from slow to fast Open	
4	4	0-255	RED 1 Red1 colour linearly increase from no-light to maximum intensity	
5	5	0-255	GREEN 1 GREEN1 colour linearly increase from no-light to maximum intensity	
6	6	0-255	BLUE 1 BLUE1 colour linearly increase from no-light to maximum intensity	
7	7	0-255	White 1 White1 colour linearly increase from no-light to maximum intensity	
8	/	0-255	RED 2 Red2 colour linearly increase from no-light to maximum intensity	
9	/	0-255	GREEN 2 GREEN2 colour linearly increase from no-light to maximum intensity	
10	/	0-255	BLUE 2 BLUE2 colour linearly increase from no-light to maximum intensity	
11	/	0-255	White 2 White2 colour linearly increase from no-light to maximum intensity	
12	/	0-255	RED 3 Red3 colour linearly increase from no-light to maximum intensity	
13	/	0-255	GREEN 3 GREEN3 colour linearly increase from no-light to maximum intensity	
14	/	0-255	BLUE 3 BLUE3 colour linearly increase from no-light to maximum intensity	
15	/	0-255	White 3 White3 colour linearly increase from no-light to maximum intensity	
16	/	0-255	RED 4 Red4 colour linearly increase from no-light to maximum intensity	
17	/	0-255	GREEN 4 GREEN4 colour linearly increase from no-light to maximum intensity	
18	/	0-255	BLUE 4 BLUE4 colour linearly increase from no-light to maximum intensity	
19	/	0-255	White 4 White4 colour linearly increase from no-light to maximum intensity	
20	/	0-255	RED 5 Red5 colour linearly increase from no-light to maximum intensity	
21	/	0-255	GREEN 5 GREEN5 colour linearly increase from no-light to maximum intensity	
22	/	0-255	BLUE 5 BLUE5 colour linearly increase from no-light to maximum intensity	
23	/	0-255	White 5 White5 colour linearly increase from no-light to maximum intensity	
24	/	0-255	RED 6 Red6 colour linearly increase from no-light to maximum intensity	
25	/	0-255	GREEN 6 GREEN6 colour linearly increase from no-light to maximum intensity	
26	/	0-255	BLUE 6 BLUE6 colour linearly increase from no-light to maximum intensity	
27	/	0-255	White 6 White6 colour linearly increase from no-light to maximum intensity	
28	/	0-255	RED 7 Red7 colour linearly increase from no-light to maximum intensity	
29	/	0-255	GREEN 7 GREEN7 colour linearly increase from no-light to maximum intensity	

64 Channel	19 Channel	DMX	Function	Note
30	/	0-255	BLUE 7 BLUE7 colour linearly increase from no-light to maximum intensity	
31	/	0-255	White 7 White7 colour linearly increase from no-light to maximum intensity	
32	/	0-255	RED 8 Red8 colour linearly increase from no-light to maximum intensity	
33	/	0-255	GREEN 8 GREEN8 colour linearly increase from no-light to maximum intensity	
34	/	0-255	BLUE 8 BLUE8 colour linearly increase from no-light to maximum intensity	
35	/	0-255	White 8 White8 colour linearly increase from no-light to maximum intensity	
36	/	0-255	RED 9 Red9 colour linearly increase from no-light to maximum intensity	
37	/	0-255	GREEN 9 GREEN9 colour linearly increase from no-light to maximum intensity	
38	/	0-255	BLUE 9 BLUE9 colour linearly increase from no-light to maximum intensity	
39	/	0-255	White 9 White9 colour linearly increase from no-light to maximum intensity	
40	/	0-255	RED 10 Red10 colour linearly increase from no-light to maximum intensity	
41	/	0-255	GREEN 10 GREEN10 colour linearly increase from no-light to maximum intensity	
42	/	0-255	BLUE 10 BLUE10 colour linearly increase from no-light to maximum intensity	
43	/	0-255	White 10 White10 colour linearly increase from no-light to maximum intensity	
44	/	0-255	RED 11 Red11 colour linearly increase from no-light to maximum intensity	
45	/	0-255	GREEN 11 GREEN11 colour linearly increase from no-light to maximum intensity	
46	/	0-255	BLUE 11 BLUE11 colour linearly increase from no-light to maximum intensity	
47	/	0-255	White 11 White11 colour linearly increase from no-light to maximum intensity	
48	/	0-255	RED 12 Red12 colour linearly increase from no-light to maximum intensity	
49	/	0-255	GREEN 12 GREEN12 colour linearly increase from no-light to maximum intensity	
50	/	0-255	BLUE 12 BLUE12 colour linearly increase from no-light to maximum intensity	
51	/	0-255	White 12 White12 colour linearly increase from no-light to maximum intensity	
52	8	0-19 20-255	CCT Invalid 2200K – 8000K	
53	9	0 - 7 8 - 15 16 - 23 24 - 31 32 - 39 40 - 47 48 - 55 56 - 63 64 - 71 72 - 79 80 - 87 88 - 95 96 - 103 104 - 111	Inter Program Invalid Scenes 1 Scenes 2 Scenes 3 Scenes 4 Scenes 5 Scenes 6 Scenes 7 Scenes 8 Scenes 9 Scenes 10 Scenes 11 Scenes 12 Scenes 13	

64 Channel	19 Channel	DMX	Function	Note
		112 - 119	Scenes 14	
		120 - 127	Scenes 15	
		128 - 135	Scenes 16	
		136 - 143	Scenes 17	
		144 - 151	Scenes 18	
		152 - 159	Scenes 19	
		160 - 167	Scenes 20	
		168 - 175	Scenes 21	
		176 - 183	Scenes 22	
		184 - 191	Scenes 23	
		192 - 199	Scenes 24	
		200 - 207	Rainbow1	
		208 - 215	Rainbow2	
		216 - 223	Rainbow3	
		224 - 231	Rainbow4	
		232 - 239	Invalid	
		240 - 247	Invalid	
		248 - 255	Invalid	
54	10	0-127	Program Speed	slow to fast (without fade)
		128-255		slow to fast (with fade)
55	11	0-255	Dimmer of Back Color(for Program)	
56	12	0-255	Red of Back Color(for Program)	
57	13	0-255	Green of Back Color(for Program)	
58	14	0-255	Blue of Back Color(for Program)	
59	15	0-255	White of Back Color(for Program)	
60	16	0-255	ZOOM left segment	Zoom linearly moves from narrow to wide beam
61	/	0-255	ZOOM right segment	Zoom linearly moves from narrow to wide beam
62	17	0-255	TILT	Moving batten linearly tilts from 0° to 190°
63	18	0-255	TILT FINE	Tilt Fine positioning
64	19	0 - 9	RESET	
		10-19	Free	
		20-29	System Reset	
		30- 39	Tilt Reset	
		40-49	Zoom Reset	
		50-59	Linear(Default)	
		60-69	Square	
		70-79	I-Square	
		80-89	S Curve	
		90-99	1000 Hz	
100-109	3600 Hz			
110-119	7200 Hz			
120-129	25000 Hz			
130-139	LED Flip on			
140-149	LED Flip off			
150-159	Fast dimmer			
160-209	Smooth dimmer			
			Free	
		210-219	Enable DMX Controller Fix the White Balance. In the extended mode, TiltCH==127 and Tilt FineCH == 127, keep it still for 3 seconds, then turn on the console to correct the white balance and continue to keep the conditions unchanged (vertical==127 and vertical trim==127 and built-in program==0 and built-in built-in program speed==127)	
		220-229	Save the WhiteBalance Value & disable DMX Controller Fix the WhiteBalance.	
		240-249	Fan&Zoom fast mode	
		250 - 255	Fan&Zoom silence mode	

6. Electrical Connection Diagram

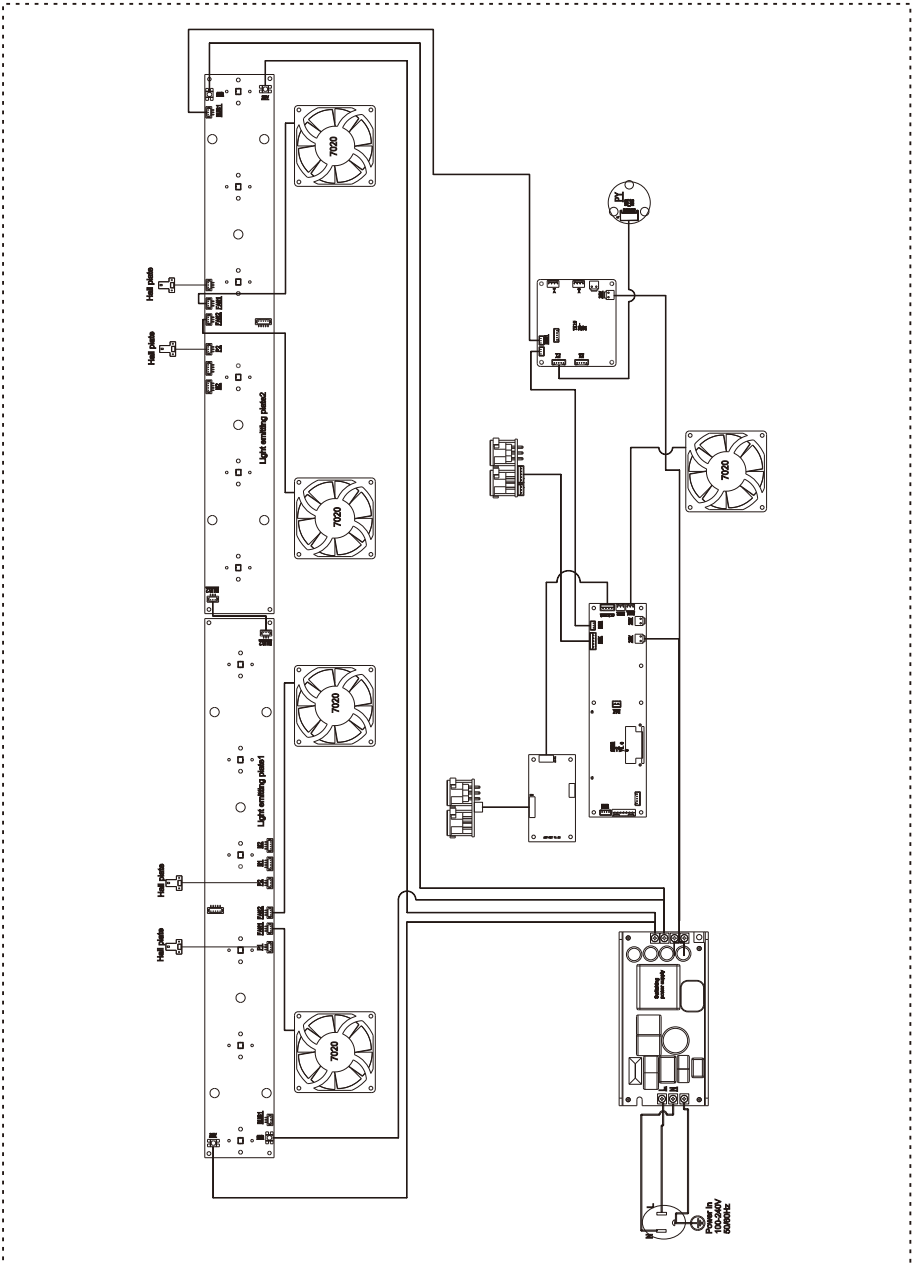

The position of each fan of the fixture:

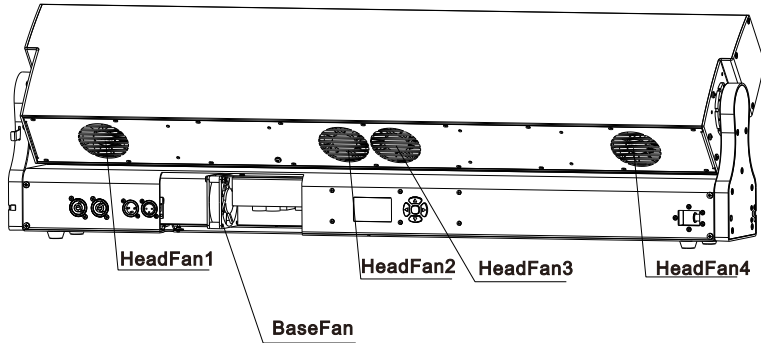

7. Troubleshooting

Following are a few common problems that may occur during operation. Here are some suggestions for troubleshooting:

A. The unit does not work, no light and the fan does not work

- Check the connected power.
- Measure the voltage.
- Check the power indicator to see whether it can be lit up or not.

B. Not responding to the DMX controller

- Check whether the DMX connectors and the DMX cables are connected correctly.
- Check whether the DMX address is correctly set.
- If the intermittent DMX signal problem occurs, check whether the XLR socket and the signal cable are well connected.
- Try it with another DMX controller.
- Check whether the DMX cables run near or alongside to the high-voltage cables, which may damage or interfere with the signal circuit.

8. Fixture Cleaning

It is absolutely essential that the fixture is kept clean to ensure the maximum light-output and allow the fixture to function reliably throughout its life. The fixture must be cleaned regularly to avoid dust, dirt and smoke-fluid residues building up on or within the fixture. The cleaning frequency depends on the application environment. Clean the fixture immediately if the dust enters it to avoid damage to the optical lens due to excessive dust.

- * A soft lint-free cloth moistened with any good glass cleaning fluid is recommended, under no circumstances should solvents be used.
- * Always dry the parts carefully.
- * Clean the external optical lens at least every 20 days and the internal optical lens every 30 days.

CAUTION ! ! !

Disconnect from mains before starting maintenance operation.

9. Duty exonerative and copyright protectio

- * Light source belongs to consumption products, not within the scope of warranty.
- * The manufacturer shall not bear any responsibility for any damage caused by failure to operate in accordance with this instruction.
- * All the information in this manual shall be interpreted by the manufacturer.
- * All the information in this manual shall not be copied without permission.
- * The data contained in this statement are subject to change in the future without prior notice.